

Copelia LIGHT-FS 180x80

PREDINSTALACIJA
PREINSTALLATION
VORINSTALLATION

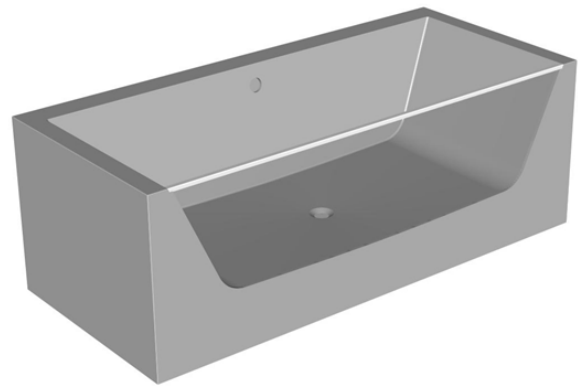
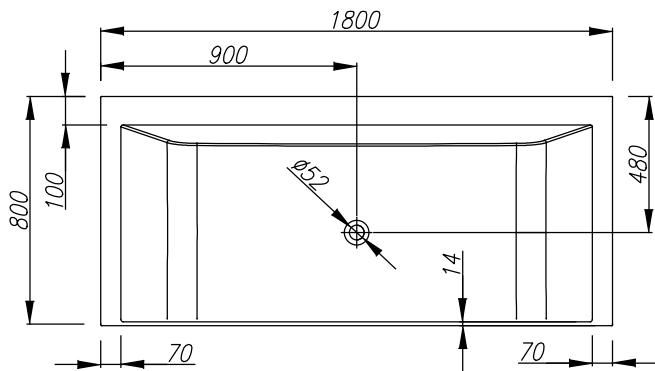
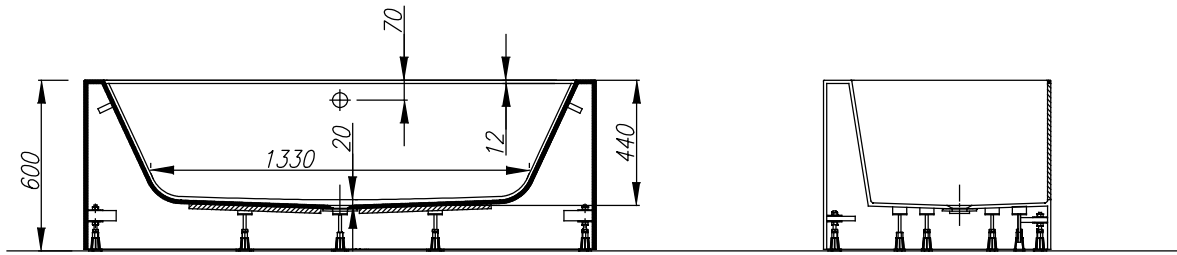
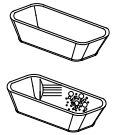

310 L

VOLUMEN
VOLUMEN
VOLUME
VOLUMEN



120 kg

TEŽA
TEŽINA
WEIGHT
GEWICHT

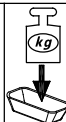

530 kg

MAX. OBREMENITEV
MAX. OBTEREČENJE
MAX. LOAD
MAX. BELASTUNG

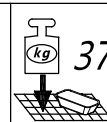

370 kg/m²

OBREMENITEV TAL
OBTEREČENJE PODA
FLOOR LOAD
BODENBELASTUNG

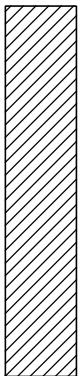

- Prostor za električni vodnik 3x2,5 mm², dolžine pribl. 1 m
- Mjesto za električni vodnik 3x2,5 mm², dužine cca. 1 m
- Spot for electrical cable 3x2,5 mm², length approx. 1 m
- Platz Stromkabel 3x2,5 mm², Länge ungefähr 1 m
- Prostor za električni vodnik 1x6 mm² za ozemljitev, dolžine pribl. 1,5 m
- Mjesto za električni vodnik 1x6 mm² za ozemljenje, dužine cca. 1,5 m
- Spot for electrical cable 1x6 mm² for earthing, length approx. 1,5 m
- Platz Stromkabel 1x6 mm² für Erdung, Länge ungefähr 1,5 m
- Priklop tople in hladne vode 1/2", min 0,2 Mpa, max 0,4 Mpa
- Priključak tople i hladne vode 1/2", min 0,2 Mpa, max 0,4 Mpa
- Connection of hot and cold water 1/2", min 0,2Mpa, max 0,4Mpa
- Anschluss Warm- und Kaltwasser 1/2", min 0,2 Mpa, max 0,4 Mpa
- Prostor za odtok Ø 50 mm
- Mjesto za odtok Ø 50 mm
- Drain spot Ø 50mm
- Abflussplatz Ø 50 mm

prporočilo za vgradnjo
preporuka za ugradnju
installation recommendation
Einbauempfehlung

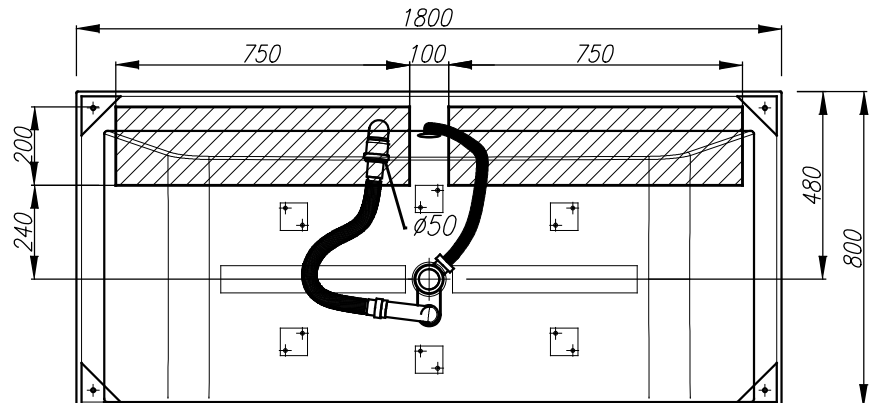

Samostoječa FS kopalna kad - navodilo za vgradnjo
FS samostojeća kada - upute za ugradnju
FS freestanding bathtub - installation instructions
FS Freistehende Badewanne - Einbauanleitung



Nr. MKKE 34

Kopalna kad iz KERROCK-a
Kada za kupanje iz KERROCK-a
Bathtub from KERROCK
Badewanne aus KERROCK

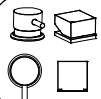

- MEŠALNI VENTIL TOPLA/HLADNA
- VENTIL ZA MIEŠANJE TOPLO/HLADNO
- MIXING VALVE HOT/COLD
- MISCHVENTIL WARM/KALT



- PREKLOPNIK ROČNA PRHA/IZLIV
- PREKIDAČ ZA RUČNI TUŠ/IZLJEV
- HAND SHOWER/SPOUT SELECTOR SWITCH
- SCHALTER FÜR HANDBRAUSE/AUSLAUF



- ROČNA PRHA
- RUČNI TUŠ
- HAND SHOWER
- HANDBRAUSE

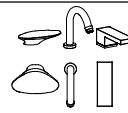

- IZLIV
- IZLJEVNIK
- SPOUT
- AUSLAUF



- IZLIV NA PRELIVNI GARNITURI
- IZLJEV NA PRELJEVNOM SETU
- SPOUT ON THE OVERFLOW SET
- AUSLAUF AN DER ÜBERLAUFGARNITUR

- OPCIJA ENOROČNA ARMATURA WATERFALL
- OPCIJA JEDNORUČNA ARMATURA WATERFALL
- OPTION ONE HAND FITTING WATERFALL
- MÖGLICHKEIT EINWEG-ARMATUR WATERFALL

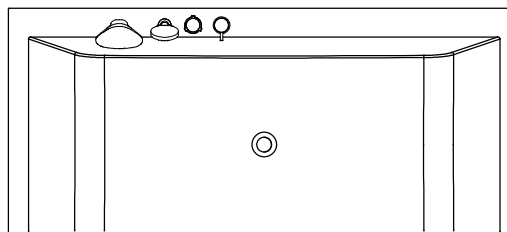
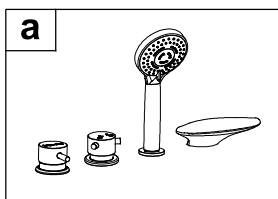

- OPCIJA ENOROČNA ARMATURA GEYSER
- OPCIJA JEDNORUČNA ARMATURA GEYSER
- OPTION ONE HAND FITTING GEYSER
- MÖGLICHKEIT EINWEG-ARMATUR GEYSER

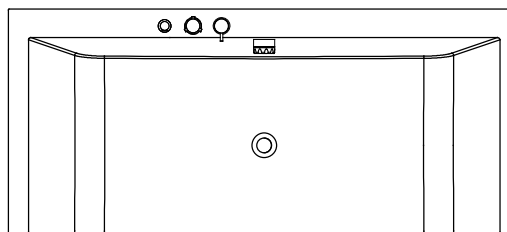
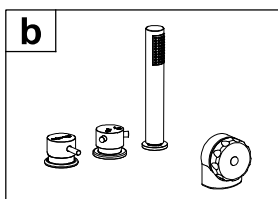

- OPCIJA ENOROČNA ARMATURA RAINDROP
- OPCIJA JEDNORUČNA ARMATURA RAINDROP
- OPTION ONE HAND FITTING RAINDROP
- MÖGLICHKEIT EINWEG-ARMATUR RAINDROP

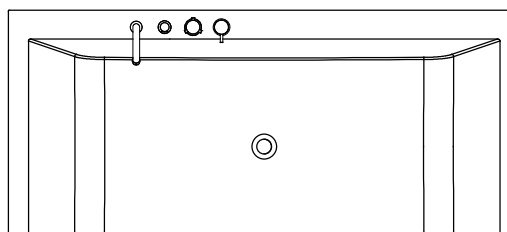
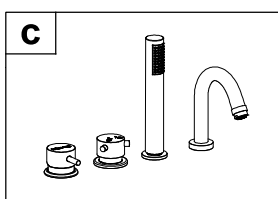

- OPCIJA ENOROČNA ARMATURA STREAM (CHR / BLACK)
- OPCIJA JEDNORUČNA ARMATURA STREAM (CHR / BLACK)
- OPTION ONE HAND FITTING STREAM (CHR / BLACK)
- MÖGLICHKEIT EINWEG-ARMATUR STREAM (CHR / BLACK)

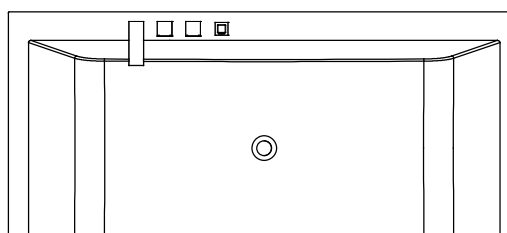
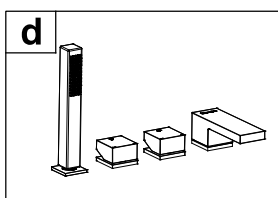

COPELIA LIGHT-FS 180x80

POLOŽAJ STIKAL IN AGREGATOV PRI RAZLIČNIH IZVEDBAH MASAŽNIH SISTEMOV MJESTO PREKIDAČA I AGREGATA KOT RAZLIČITIH IZVEDBI MASAŽNIH SISTEMA POSITION OF SWITCHES AND GENERATORS IN DIFFERENT VERSIONS OF MASSAGE SYSTEMS POSITION SCHALTER UND AGGREGATE BEI VERSCHIEDENEN AUSFÜHRUNGEN VON MASSAGESYSTEMEN

3/3

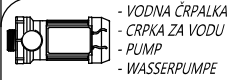

- VODNA ČRPALKA
- CRPKA ZA VODU
- PUMP
- WASSERPUMPE



- VODNE ŠOBE
- VODNE MLAZNICE
- WATER JETS
- WASSERDÜSEN



- REGULATOR ZRAKA
- REGULATOR ZRAKA
- AIR CONTROLLER
- LUFTREGLER



- ELEKTRONSKA STIKALA
- ELEKTRONSKI PREKIDAČI
- ELECTRONIC SWITCHES
- ELEKTROSCHALTER



- ARMATURA IN TUŠ ROČICA
- PIPA I TUŠ
- FIXTURE AND SHOWER HANDLE
- WASSERHAHN UND DUSCHE

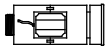

- ZRAČNI KOMPRESOR
- ZRAČNI KOMPRESOR
- BLOWER
- LUFTPUMPE



- ZRAČNA ŠOBA
- ZRAČNA MLAZNICA
- AIR JET
- LUFTDÜSE



- PNEVMATSKO STIKALO
- PNEVMATSKI PREKIDAČ
- PNEUMATIC SWITCH
- PNEUMATIKSCHALTER



- LUČ ALI CHROMOTERAPIJA
- SVJETLO ILI CHROMOTERAPIJA
- LIGHT OR CHROMOTHERAPY
- LICHT ODER CHROMOTHERAPIE



- PREKLOPNIK ZA MIKROŠOBE
- PREKIDAČ ZA MIKROMLAZNICE
- MICROJET SWITCH
- SCHALTER FÜR MIKRODÜSEN

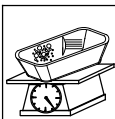
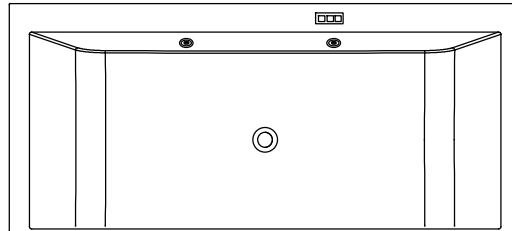

TEŽA
TEŽINA
WEIGHT
GEWICHT
123 kg

CHROMOTERAPIJA

- ELEKTRONSKO STIKALO
- CHROMOTERAPIJA 2xLED

CHROMOTERAPIJA

- ELEKTRONSKI PREKIDAČ
- CHROMOTERAPIJA 2xLED

CHROMOTHERAPY

- ELECTRONIC SWITCH
- CHROMOTHERAPY 2xLED

CHROMOTHERAPIE

- ELEKTROSCHALTER
- CHROMOTHERAPIE 2xLED

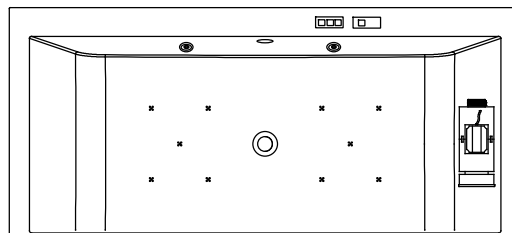

TEŽA
TEŽINA
WEIGHT
GEWICHT
131 kg

ZRAČNI MASAŽNI SISTEM + CHROMOTERAPIJA

- ZRAČNI KOMPRESOR P=800W
- ELEKTRONSKO STIKALO
- 10 ZRAČNIH ŠOB
- CHROMOTERAPIJA 2xLED

ZRAČNI MASAŽNI SISTEM + CHROMOTERAPIJA

- ZRAČNI KOMPRESOR P=800W
- ELEKTRONSKI PREKIDAČ
- 10 ZRAČNIH MLAZNICA
- CHROMOTERAPIJA 2xLED

AIR MASSAGE SYSTEM + CHROMOTHERAPY

- BLOWER P=800W
- ELECTRONIC SWITCH
- 10 AIR JETS
- CHROMOTHERAPY 2xLED

LUFT MASSAGESYSTEM + CHROMOTHERAPIE

- LUFTPUMPE P = 800 W
- ELEKTROSCHALTER
- 10 LUFTDÜSEN
- CHROMOTHERAPIE 2xLED